



**CUINSOL**  
soler ruíz s.l.

## 04 - Puertas y Módulos Cocina

	Pag
Puertas Sun HPL	46
Puertas Veneto PET	47
Puertas Tmatt Melamina Lacada	48
Puertas Moon Melamina	49
Tiradores Puertas	50
Puertas J-Line Pet-Melamina	51
Puertas Lacadas-Madera	52
Modulos Cocina	53
Tableros Melamina	54
Encimeras y Mostradores HPL	55
Encimeras Porcelanico - Cooking 3.0	56



BLANCO BRILLO



CICLON BRILLO

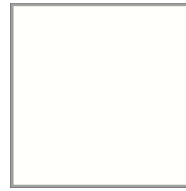

BLANCO MATE



CICLON MATE



Fabricación Propia  
Servicio Express



**Descripción:**

- Acabado: 4 cantos
- Cara: HPL
- Trasera: HPL
- Tablero: Aglomerado
- Grosor Mate: 19mm
- Grosor Brillo: 20mm
- Tablero: 3060x1320mm

**Características Técnicas:**

- Antibacteriano
- Resistencia a la humedad
- Inalterable al paso del tiempo
- Resistente a las manchas
- Resistente a la abrasión y rayado

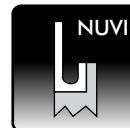
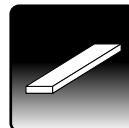

**Canto Láser Rehau**



# Puertas Veneto PET

2023

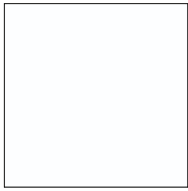

PEB-070 BRILLO



PEM-060 MATE

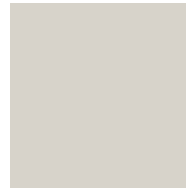

PEM-058 MATE



PEM-061 MATE



PEM-055 MATE



PEM-056 MATE



PEM-057 MATE



PEM-064 MATE



Fabricación Propia  
Servicio Express

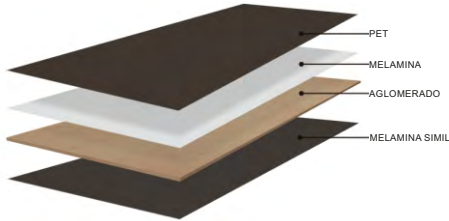

### Descripción:

- Acabado: 4 cantos
- Cara: PET
- Trasera: Melamina simil
- Tablero: Aglomerado
- Grosor: 19mm
- Tablero: 2800x1220mm

### Características Técnicas:

- Antibacteriano
- Antihuellas, tacto seda
- Inalterable al paso del tiempo
- Libre de PVC, material reciclado
- Resistente a las manchas
- Resistente al calor de la luz
- Resistente a la abrasión y rayado
- Resistente a los disolventes

premium **pet**

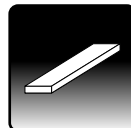
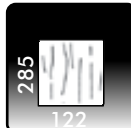

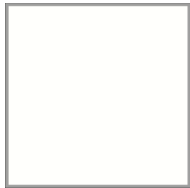

BLANCO MATE

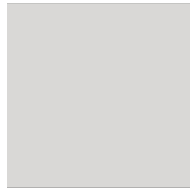

NUVOLA MATE

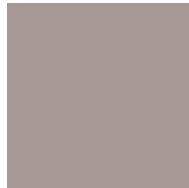

ARENA MATE



ANTRACITA MATE

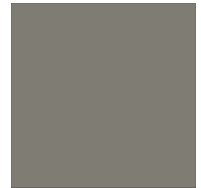

VISON MATE



NEGRO MATE



AZUL MATE



VERDE MATE



TERRACOTA MATE



 Fabricación Propia  
 Servicio Express

**Descripción:**

- Acabado: 4 cantos
- Cara: Melamina lacada
- Trasera: Melamina simil
- Tablero: DM
- Grosor: 18mm
- Tablero: 2850x1220mm

**Características Tecnicas:**

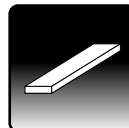
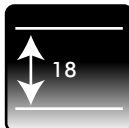
- Melamina lacada
- Antibacteriano
- Autoregenerador
- Antihuellas, tacto seda
- Resistente golpes
- Resistente al rayado



# Puertas Moon Melamina

2023



H3700 ST10

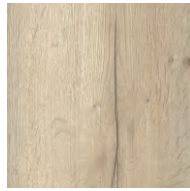

H1176 ST37



H1180 ST37

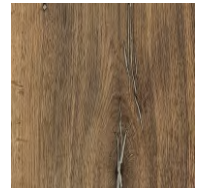

H3176 ST37



H1401 ST22



H3331 ST10



H3734 ST9



Fabricación Propia  
Servicio Express

### Descripción:

- Acabado: 4 cantos
- Cara: Melamina
- Trasera: Melamina
- Tablero: Aglomerado
- Grosor: 19mm
- Tablero: 2800x2070mm

### Características Técnicas:

- Melamina simil madera
- Antibacteriano
- Resistente golpes
- Resistente al rayado

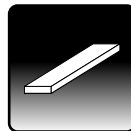
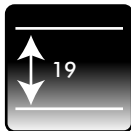



## Tirador Nuvi Aluminio

Código	Descripción	Acabado	U.M.
51110030	Tirador Nuvi Alto	Plata Mate	ud
51110032	Tirador Nuvi Bajo	Plata Mate	ud
51110034	Tirador Nuvi Alto	Aluminio Inox	ud
51110035	Tirador Nuvi Bajo	Aluminio Inox	ud
51110036	Tirador Nuvi Alto	Blanco Brillo	ud
51110037	Tirador Nuvi Bajo	Blanco Brillo	ud
51110038	Tirador Nuvi Alto	Blanco Mate	ud
51110039	Tirador Nuvi Bajo	Blanco Mate	ud
51110040	Tirador Nuvi Alto	Negro Mate Liso	ud
51110041	Tirador Nuvi Bajo	Negro Mate Liso	ud
51110042	Tirador Nuvi Alto	Negro Mate Soft	ud
51110043	Tirador Nuvi Bajo	Negro Mate Soft	ud
51110044	Tirador Nuvi Alto	Antracita Liso	ud
51110045	Tirador Nuvi Bajo	Antracita Liso	ud
51110046	Tirador Nuvi Alto	Antracita Soft	ud
51110047	Tirador Nuvi Bajo	Antracita Soft	ud

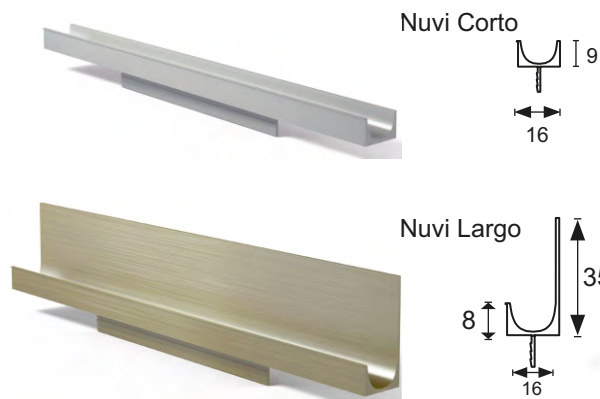

## Tirador Eva Aluminio

Código	Descripción	Acabado	U.M.
51110051	Tirador 918/18mm	Plata Mate	ud
51110052	Tirador 919/19mm	Plata Mate	ud
51110053	Tirador 920/20mm	Aluminio Inox	ud
51110055	Tirador 918/18mm	Aluminio Inox	ud
51110056	Tirador 919/19mm	Blanco Brillo	ud
51110057	Tirador 920/20mm	Blanco Brillo	ud
51110061	Tirador 918/18mm	Blanco Mate	ud
51110062	Tirador 919/19mm	Blanco Mate	ud
51110063	Tirador 920/20mm	Negro Mate Liso	ud
51110065	Tirador 918/18mm	Negro Mate Liso	ud
51110066	Tirador 919/19mm	Negro Mate Soft	ud
51110067	Tirador 920/20mm	Negro Mate Soft	ud



# Puertas J-Line

2023

## Diseños PET



## Diseños Melamina



**fi Top Form**  
Group

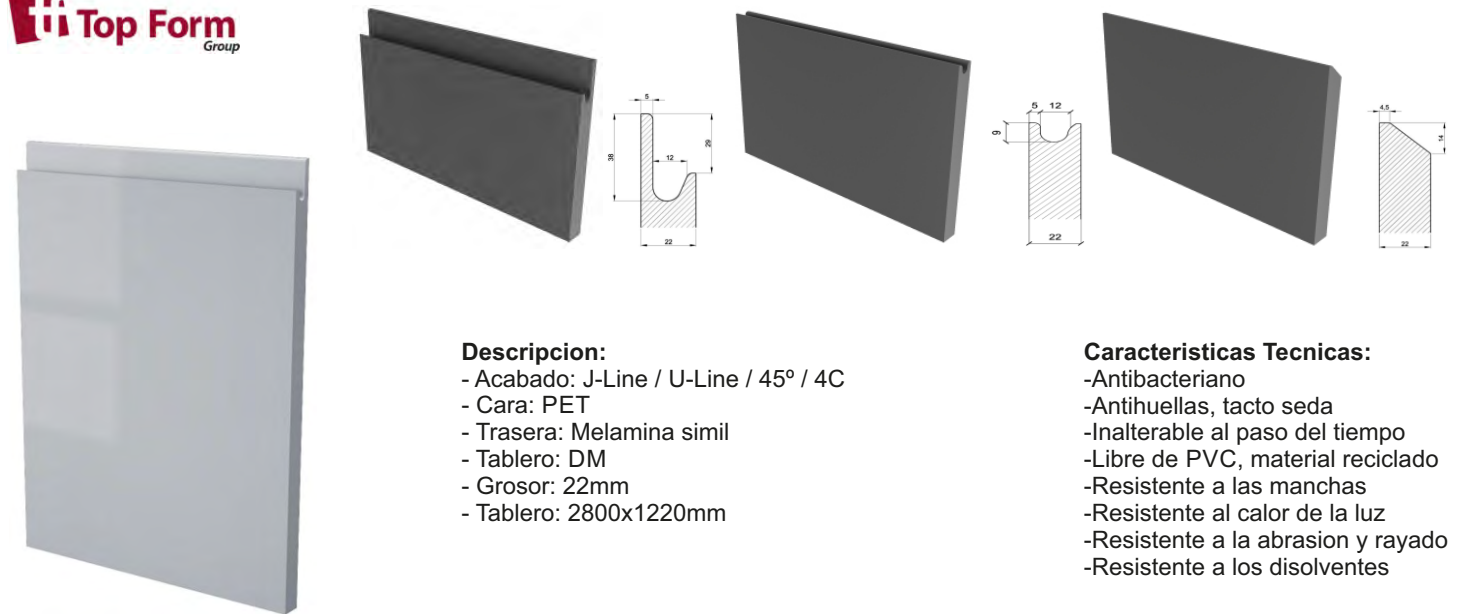

### Descripción:

- Acabado: J-Line / U-Line / 45° / 4C
- Cara: PET
- Trasera: Melamina simil
- Tablero: DM
- Grosor: 22mm
- Tablero: 2800x1220mm

### Características Técnicas:

- Antibacteriano
- Antihuellas, tacto seda
- Inalterable al paso del tiempo
- Libre de PVC, material reciclado
- Resistente a las manchas
- Resistente al calor de la luz
- Resistente a la abrasión y rayado
- Resistente a los disolventes





Laca Toronto 22mm



Laca Coral + Tirador 1043



Vesubio Synchron



4Cantos Synchron + Tirador Open



Fuji Aluminio + Porcelanico





# Modulos Cocina

2023

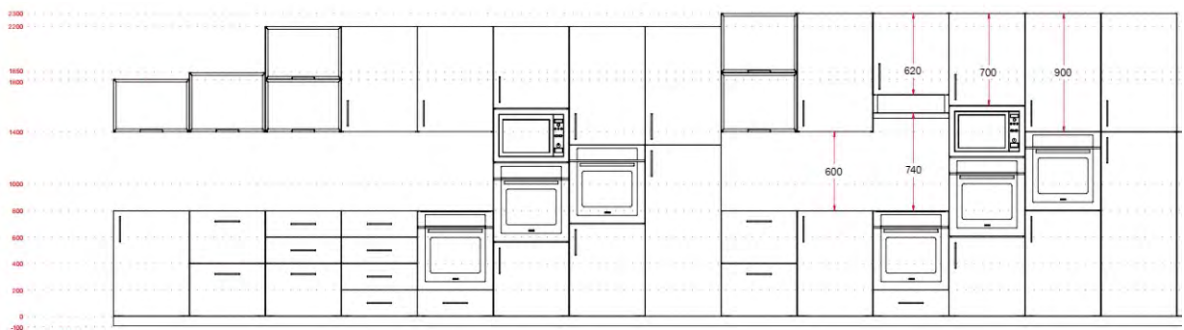

Módulos formato kit, tablero melamina Hidrófugos y Antibacteriano de 16/19mm  
 -Tablero aglomerado melaminico dos caras  
 -Frontales canteados PVC 1mm, resto PVC 0,4mm  
 -Traseras 6mm dos caras



## Modulos 16mm



Blanco Medio  
Soft III



Aluminio  
Soft III

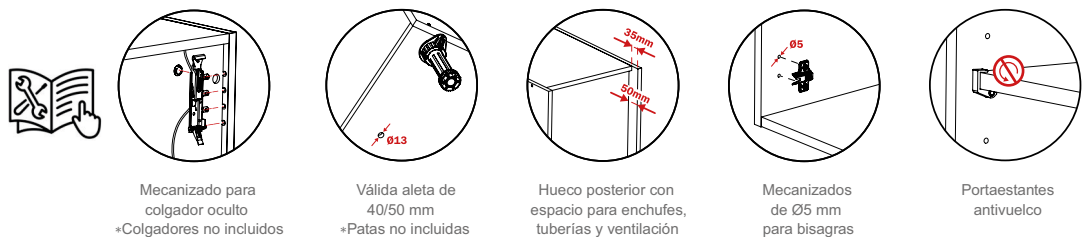

Mecanizado para colgador oculto  
\*Colgadores no incluidos

Válida aleta de 40/50 mm  
\*Patas no incluidas

Hueco posterior con espacio para enchufes, tuberías y ventilación

Mecanizados de Ø5 mm para bisagras

Portaestantes antivuelco

## Modulos 19mm



Antracita  
Gris Gu Soft III

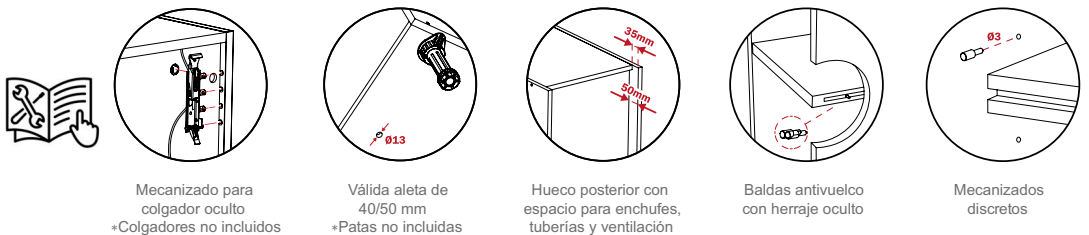

Mecanizado para colgador oculto  
\*Colgadores no incluidos

Válida aleta de 40/50 mm  
\*Patas no incluidas

Hueco posterior con espacio para enchufes, tuberías y ventilación

Baldas antivuelco con herraje oculto

Mecanizados discretos

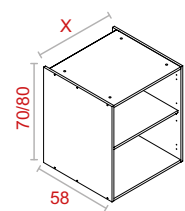

Módulo Bajo

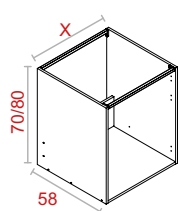

Módulo Fregadero

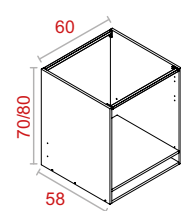

Módulo Horno

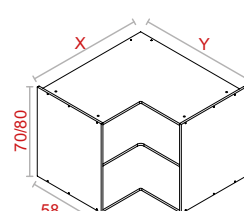

Módulo Esquina "L"

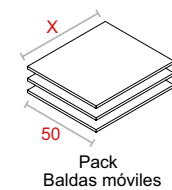

Pack Baldas móviles

X 56,7 (60)

X	15	30	35	40	45	50
	60	70	80	90	100	120

X	45	50	60	70
	80	90	100	120

X	Y
93	x 93

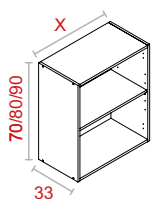

Módulo Alto

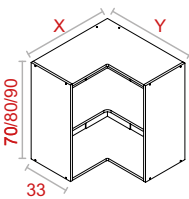

Módulo Esquina "L"

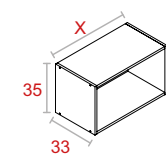

Módulo Transversal

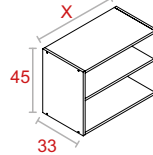

Módulo Transversal

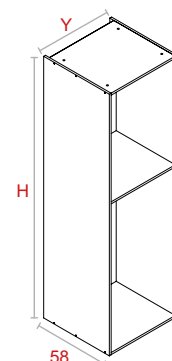

Columna Dispensero

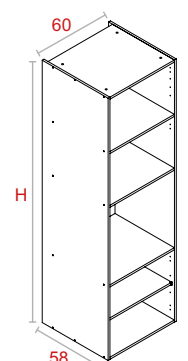

Columna Horno+Micro

X	30	35	40	45	50
	60	70	80	90	100

X	Y
63	x 63

X	60   90
---	---------

X	60   90
---	---------

HxY	200x60
	220x60

H	200   220
---	-----------



## FINSA Servicio de Corte y Canteado

- Servicio de corte y optimización del tablero.
- Servicio de canteado de máxima calidad:
  - Canteado cola EVA.
  - Canteado Láser (maquina ultima generación)

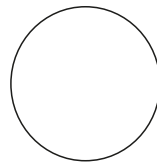

### Tablero Melamina Blanco S3

Código	Descripción	U.M.
80220001	2440x1220x6mm DM	ud
80220003	2440x1220x16mm	ud
80220004	2440x1220x19mm	ud

### Tablero Melamina Blanco Liso

Código	Descripción	U.M.
80220011	2440x1220x10mm	ud
80220012	2440x1220x16mm	ud
80220013	2440x1220x19mm	ud

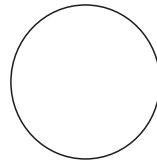

### Tablero Superpan Blanco S3

Código	Descripción	U.M.
80220031	2440x1220x10mm	ud
80220032	2440x1220x16mm	ud
80220033	2440x1220x19mm	ud

### Tablero Superpan Blanco Liso

Código	Descripción	U.M.
80220041	2440x1220x10mm	ud
80220042	2440x1220x16mm	ud
80220043	2440x1220x19mm	ud

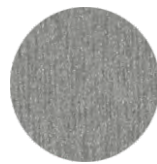

### Tablero Melamina Gris S3

Código	Descripción	U.M.
80220101	2850x2100x6mm DM	ud
80220102	2440x1220x16mm	ud



### Tablero Melamina Antracita S3

Código	Descripción	U.M.
80220201	2440x2100x6mm DM	ud
80220202	2440x2100x10mm	ud
80220203	2440x2100x16mm	ud
80220204	2440x2100x19mm	ud



### Tablero Melamina Hidrofuga S3

Código	Descripción	U.M.
80220022	2850x2100x16mm Blanca S3	ud
80220112	2440x1220x16mm Gris S3	ud



### Tablero Melamina Tissue Textil

Código	Descripción	U.M.
80220401	2850x2100x10mm	ud
80220402	2850x2100x16mm	ud
80220403	2850x2100x19mm	ud

# Encimeras y Mostradores HPL

2023

top-collection **hpl**



Recubrimiento: Laminado Alta Presión - HPL

Soporte:

- Estándar: Tablero aglomerado de partículas
- Hidrófugo: Tablero aglomerado hidrofugo

Cantos:

- Supra R3
- Canteado Recto

Espesores:

- 30mm
- 38mm



Calidades:

- Calidad Eco
- Calidad Supra

Medidas Encimeras:

- Largo: 3600mm
- Fondo: 620mm

Disponibles mostradores: desde 400mm a 1240mm

## Diseños:

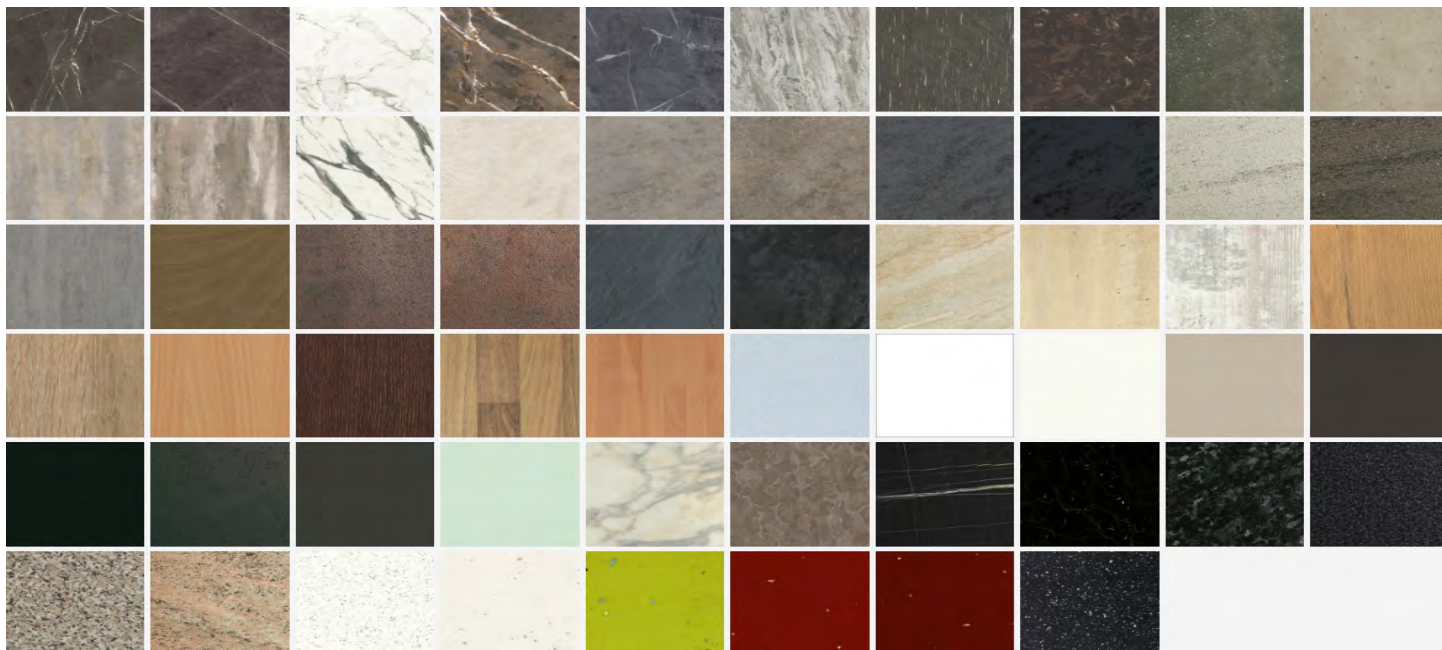

## Composicion:

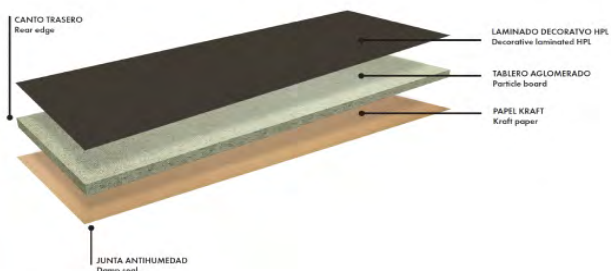

## Post-R3:

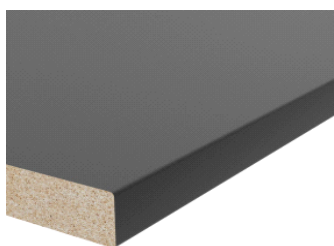

## Canteado Recto:

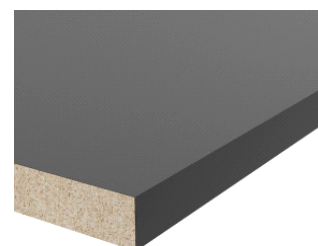



**COOKING**  
SURFACE PRIME



La primera encimera con la inducción integrada 100% invisible. Gana espacio, tiempo y la calidad de vida que mereces. Revoluciona tu cocina creando un ambiente único y vanguardista donde aprovechar cada centímetro.

La encimera Cooking 3.0, solo se puede instalar con porcelanico 20mm de ABK.

### Cooking 3.0:

Garantía 5 años  
3 fuegos 5500w  
Mando con cable oculto  
App disponible  
Solo se instala sobre porcelanico 20mm  
Certificado CE

### Porcelanico ABK:

Garantía: 25 años  
Grosos: 12mm / 20mm  
Juntas invisibles  
Resistente al fuego, rayado y abrasion  
Facil limpieza, resiste acidos y manchas

### Cooking Surface 3.0

Código	Descripción	U.M.
89010101	Induccion Cooking Surface 3.0	ud
89010102	Baterial Cocina Cookware (6u)	ud
89010103	Encimera Porcelanico 12mm	ml
89010104	Encimera Porcelanico 20mm	ml

### Colores Disponibles Porcelanico 12mm/20mm

